



OPERATIONAL MANUAL
Part A – General / Basic

8. Operational Procedures
8.2 Ground operational instructions

Section 8.2

Review 24

Page 1

8.2 Ground Handling Instructions

The company has the appropriate and sufficient ground support to perform the operations.

CLIPPER NATIONAL AIR sends a copy of this Section 8.2 and 9 of the MOA to all handling operators that it hires, as well as a questionnaire where the individual responsible for the handling company ensures that all personnel serving CLIPPER aircrafts has the information and training necessary to meet our procedures in these sections of the MOA.

The pilots will send a report to the FOR if there is some disagreement about the service received from handling hired at the aerodrome, to inform the GOR, responsible for their hiring.



OPERATIONAL MANUAL
Part A – General / Basic
8. Operational Procedures
8.2 Ground operational instructions

Section 8.2

Review 24

Page 2

INTENTIONALLY LEFT BLANK

	MANUAL DE OPERACIONES Parte A – General / Básico	Sección 8.2.1
	8. Operational procedures 8.2 Ground operational instructions	Revisión 24
	8.2.1 Fuel management procedures	Pág. 1

8.2.1 Procedures of fuel management

The management of each airport, the fuel suppliers and the operators should assume their individual responsibilities during fuel loading / unloading. At this point CLIPPER NATIONAL AIR standards for this operation should be followed.

Individual states or Airport Authority may impose additional requirements, in which case, flight dispatch or the handling company contracted will establish appropriate measures of compliance, reporting any concerns to the Captain.

When the aircraft is assigned for duty, the loading / unloading operations, even when performed by anyone other than the Company, are the responsibility of the Captain.

They should:

- Check the type of tanker refueling and check the fuel type.
- Supervise Refuelling
- Sign and file proof of refueling.



**MANUAL DE OPERACIONES
Parte A – General / Básico**

8. Operational procedures
8.2 Ground operational instructions
8.2.1 Fuel management procedures

Sección 8.2.1

Revisión 24

Pág. 2

8.2.1.a SAFETY MEASURES DURING THE FUEL SUPPLY AND DISCHARGE

- 1) A portable fire extinguisher should be provided in order to react against initial cases of fuel fire. Extinguishers that are normally equipped in tank vehicles are considered sufficient to meet this requirement.
- 2) All loading / unloading is performed outside, never inside the hangars.
- 3) In an electrical storm, during loading / unloading operations, maximum security precautions should be taken and any operations should be stopped if lightning strikes near the airport.
- 4) Loading / unloading should be avoided, when any part of the landing gear is abnormally overheated; loading / unloading should be stopped or postponed until abnormal levels of excess heat are dealt with.
- 5) One should be especially careful to avoid spills, and not to turn on the engines until the spilled fuel has been cleaned away.
- 6) The electrical and / or electronic systems, except the radar, can be operated as long as necessary during pre-flight operations.
- 7) Fuel will not be charged / discharged and any operation will stop when there is an aircraft with engines running in the immediate vicinity of the area.
- 8) The batteries on the plane should not be installed, connected or disassembled. The generators for charging batteries must also not be operated or disconnected.
- 9) No electricity generators should be connected.
- 10) No power tools, drills or similar equipment that may produce sparks should be used; Furthermore no electronic or electrical flashes should be used to take pictures in the vicinity of refueling equipment, in particular, filling holes or vents of the aircraft
- 11) When staff are involved in the loading / unloading is strictly prohibited to use lighters or matches.
- 12) The presence of open flames or devices capable of producing them, is strictly prohibited in places located less than fifty feet from where you are performing any refueling operation. In the category of such flames, and devices capable of producing them, are included among others:
 - i) Lit cigarettes and pipes.
 - ii) Fired heaters.
 - iii) Burners.
 - iv) Torches.
- 13) Refueling operations are prohibited while engines are running.
- 14) During the loading / unloading of fuel, Electrostatic charges may accumulate on the surface of the aircraft or tank vehicle, or both, that can create hazardous conditions. In order to prevent electrostatic discharge, tanks, metal parts of the pipes and the aircraft must be connected, just as the aircraft is, to land.
- 15) Among the security measures during refueling, guidelines and precautions to take, the following is written:
 - The approach and positioning of the fuel supply vehicle:
 - C550 y C510 is positioned over the nose



- Setting up the fueling area:
 - It is outlined by the cones
- Connecting the ground wire:
 - Completed by the tank operator.
 - Whenever the hose is in contact with the plane, the deviation to ground must be set.
- Presence of fire extinguishers.
- The pilot is responsible for overseeing the supply of fuel, paying special attention to the verification of the refueling amount.
- Disconnect the ground wire.
- Exit the refueling vehicle.

8.2.1.b FILLING AND DISCHARGE OF FUEL WHEN PASSENGER ARE EMBARKING, ON BOARD, OR DISEMBARKING

The Company will only contemplate refueling or fuel discharge with passengers on board if it is guaranteed that the aircraft will not have fuel taken out, or be refueled with Avgas or high volatility fuel (ex Jet-B or equivalent), or with a mixture of these fuel types, when passengers are on board.

For operational reasons, due to the interest in reducing the duration of ground traffic or passenger comfort, States exceptions allow passengers to remain on board the aircraft, while loading / unloading fuel is performed, provided certain conditions are met.

States or airport authorities may impose the additional rules listed below, which must be completed by Handling.

At airports where this practice is permitted, regardless of the specifics of each of these rules, the following shall apply:

- (1) The pilot must remain in the cabin with passengers to ensure the implementation of procedures related to: firefighting, communication with passengers and the control tower, and the management of a possible evacuation;
- (2) A two-way communication system between the ground crew supervising the refueling and the qualified personnel on board the airplane shall be established and maintained through the internal communication system of the aircraft or other suitable means.
- (3) Crew, staff and passengers must be warned that the fuel supply or discharge will take place;
- (4) Seat belt signs must be switched off;
- (5) No-smoking signs and interior lighting to enable the identification of emergency exits and opening devices must be illuminated.
- (6) Instructions shall be given to passengers to unfasten seatbelts and to refrain from smoking;



**MANUAL DE OPERACIONES
Parte A – General / Básico**

8. Operational procedures
8.2 Ground operational instructions
8.2.1 Fuel management procedures

Sección 8.2.1

Revisión 24

Pág. 4

- (7) If the presence of fuel gas is detected in the aircraft or any other hazard in the supply / discharge occurs, the operation should be stopped immediately;
- (8) The ground area under the exits should be kept clear for emergency evacuation. Evacuation routes must be free of FOD,
- (9) The Pilot on board must prepare for possible evacuation via the front door.
- (10). Provided there are no legal impediments and there are sufficient numbers of personnel to ensure their evacuation, the pilot may authorize the presence of passengers with diminished capacity during loading / unloading on board, even if the rest of the passengers have disembarked from the aircraft.
- (11) In case of a patient flight on a stretcher, the CM1 will ask To doctors who prepare the patient for a possible evacuation.

8.2.1.c PRECAUTIONS TO BE TAKEN INTO ACCOUNT TO PREVENT FUEL MIXTURE.

The crew must:

- Coordinate with the supplier the particular type of fuel required.
- Check the delivery note of the type of fuel delivered.
- Check the proof of refueling before signing.
- The responsibility for these precautions is the driver who is supervising the refueling, who records this by signing the delivery note.



**MANUAL DE OPERACIONES
Parte A – General / Básico**

8. Operational procedures
8.2 Ground operational instructions
8.2.1 Fuel management procedures

Sección 8.2.1

Revisión 24

Pág. 5

INTENTIONALLY LEFT BLANK



8.2.2 Operational Procedures for the safety of the aircraft, passengers and cargo

The Company will hire the corresponding handling team at each airport that will be responsible for the identification of hold baggage and will ensure that they pass the security check before being loaded on the plane.

There should be no one onboard the aircraft or the stairs unless there is also present, a member of the technical crew who:

- Has the means to operate the plane
- Has the means to initiate an evacuation
- Knows their responsibilities on board as specified in the Operations manual-
- Knows at all times the position of vehicles and cargo service in or near exits

In addition to operational procedures below

1. Approach and positioning equipment

- In the approach and departure of the aircraft the equipment shall move at the speed of a person walking (8 km / h).
- In low visibility conditions the driver of the vehicle or equipment shall be guided by another person to guide them to their approach to aircraft using standard visual signals.
- Vehicles and unattended ramp equipment located near the plane have their engines turned off, in neutral with the hand brake on.

2. Placing chocks.

Will be completed after the indication of the member of handling responsible provided that the aircraft has completely stopped its engines.

They should always be touch the wheels, first in the front and then the rear.

In case of **strong winds** the chocks will be placed after the motors are turned off 4 chocks to the main gear and 2 chocks in front.

The chocks can be removed only with permission of pilot.

FAILURE TO FOLLOW THIS PROCEDURE MAY RESULT IN THE PLANE ROLLING UNCONTROLLABLY CREATING RISKS TO PERSONAL ASSISTANCE AND OTHERS



3. Placement of cones.

Once the engines have stopped and the chocks are in position, personnel can proceed with placing cones. These cones should be placed in order to identify areas of circulation around the parked aircraft and should be removed once the aircraft is ready to be turned on.

A cone will be placed near the wingtip and another near the tail on the side of the plane which corresponds with the aircraft's exit.

4. F.O.D.

The handling personnel under the supervision of the Captain, will ensure that the track surface is clean of objects that may damage the aircraft or its engines before departure.

Before the arrival, the Control Tower will allocated parking and Handling personnel should notify if the runway is not in clean condition for the plane.

5. Prevention of accidents.

- Vehicles required for operations will not approach the aircraft until they have received authorization from the responsible member of handling.
- They will not open or close the doors until authorized by the pilot
- The handling hired by the Company shall appoint a coordinator to be responsible for the operation of ground handling. Before this, the Company will have sent a copy of the procedures used in the operation of ground handling of its aircraft.

	MANUAL DE OPERACIONES Parte A – General / Básico 8. Operational Procedures 8.2 Ground operational instructions 8.2.2 Aircraft safety operating procedures Passangers and cargo	Sección 8.2.2
		Review 38
		Pág. 3

8.2.2.a. SPECIAL PASSENGER INCLUDING CHILDREN / BABIES, SICK PASSENGERS AND PERSONS WITH REDUCED MOBILITY

a.1.Minors

For transportation purposes a minor is considered to be a person who has not reached the age of TWELVE by the date of the flight and it has more than seven days.

INFANT: Not reached the age of TWO before the date of the flight. They travel without their own seat, accompanied by a person over 18 years of age.

CHILD: Over the age of TWO but under the age of TWELVE. Children should travel occupying their own seat.

a.1.1. Oxygen masks by aircraft, and onboard floating elements

- 1) The C-S550 have two additional oxygen masks and the C-510 has one. It used to supply oxygen to the baby (infant), which carries the adult and go installed on the roof of the cabin.
- 2) Life jackets on board. Whenever you need to fly over water, provision of vests on board must contain the required number of vests or appropriate cribs for children to be flown.

a.1.2. Occupation seats for children

a.1.2.1. Infant

Babies do not require a seat. The adult responsible for the child during the flight, provided that the mandatory use of seat belt is respected, will hold the baby in their arms on their knees.

Do not let the baby travel using the same belt as the person accompanying him. The permitted number of babies on board is limited to two

In the C-S550 two babies can be transported and in the C-510 only one.

A.1.2.2 Occupation of seats for two children (SOD)

More than one person occupying a seat is not allowed unless one is an adult and the other a baby.

To meet the rules governing the distribution of oxygen in the case of a drop in cabin pressure, the grouping of one adult and one child is only allowed in the row of seats in which an additional mask is available

a.1.3. Unaccompanied minors

The Company does not accept this type of transport

	MANUAL DE OPERACIONES Parte A – General / Básico 8. Operational Procedures 8.2 Ground operational instructions 8.2.2 Aircraft safety operating procedures Passangers and cargo	Sección 8.2.2
		Review 24
		Pág. 4

a.2. Persons with Reduced Mobility and Passengers with Diminished Capacity

Refers to all passengers:

- That, given its special physical or mental conditions, need more individual attention than normal given to another passenger, while traveling, during a possible emergency evacuation and / or ashore. These special psychophysical conditions are noted on the occasion of claims or statements made by the passengers and / or their families or by any medical authority or have been observed and reported by the staff of the Airlines or persons associated with the Industry (Agents, etc .)

Note: Among the passengers mentioned above are those who have serious difficulties in receiving or understanding emergency instructions.

- Those who could suffer deterioration in health, due to air travel.

Passengers with diminished capacity, because of their mobility can be classified into:

- Outpatient: Able to raise, lower, or move within the aircraft unaided or with little help from anyone else, for example someone deaf, blind or with learning difficulties.
- Non Outpatient: Not able to raise, lower, or move within the aircraft unassisted.

a.2.1. Valid companion

A person, older than 18, in full possession of his faculties who goes with the passenger with diminished capacity, in order to provide the assistance they may require during the trip.

They will be informed of safety procedures and the position of the emergency exits and the path that must be followed in case of evacuation, information that will be provided on board by the crew cabin.

Companions of ambulatory passengers, even blind, may be under 18.

A guide dog is considered as valid companion for a blind or deaf person traveling alone.

a.2.2. Companies specializing in care and transport of sick and wounded (EATEH)

They are doing transport aircraft CLIPPER NATIONAL AIR with own professional staff with medical support equipment on board. CLIPPER NATIONAL AIR establish cooperation agreements with these companies.

- The staff of these companies have a proof of identity and authority for the transport of sick / injured in aircraft CLIPPER NATIONAL AIR, which shall exhibit the crew, being sufficient accreditation to transport these passengers. (INCAD is not required).

	MANUAL DE OPERACIONES Parte A – General / Básico 8. Operational Procedures 8.2 Ground operational instructions 8.2.2 Aircraft safety operating procedures Passangers and cargo	Sección 8.2.2
		Review 24
		Pág. 5

- The competent services of the Company have taken steps to equip aircraft devices and mechanisms that may be needed for this type of transport measures, without security of passengers and aircraft decline.

Annexed to the contract CLIPPER NATIONAL AIR with these companies, a catalog of every auxiliary medical equipment that the company plans to use in their daily activity is included. In the same shall be declared authorization CLIPPER NATIONAL AIR to such equipment before use or transportation in cabin or hold. This procedure must pass the new equipment in the future as needed. The devices have a label that indicated its name, its validity and authorization CLIPPER NATIONAL AIR.

a.2.3. Authorisation for transport

When medically fit to travel is required, may grant it only authorized by the Company doctors if the limitations of the maximum number of passengers, other safety standards are met and requisite formalities are completed.

The authorization of the Medical Service is the only valid take on board a passenger requires medical clearance to travel between.

The ROT, comprise the passenger's name, flight number, date, route and supplementary means (stretcher, oxygen, etc.) and companions if specified.

Previously the passenger or have completed a representative documents and requirements of the Medical Service, which in view of these issues or not authorization.

a.2.4. Medicinal oxygen (Therapeutic)

The transport of medical oxygen required authorization of the Medical Service. Oxygen cylinders supplied by CLIPPER NATIONAL AIR will be accepted. May not be on board passenger own bottles for use in the cabin.

Stretchers have their own oxygen and service certificate will be the only ones allowed to board planes of the Company.

a.2.5. Acceptance

These rules and instructions apply to the carriage on flights CLIPPER NATIONAL AIR exclusively. If an itinerary also includes trips on other airlines, the acceptance conditions may differ, especially regarding provision of equipment and / or extra charges. The requirements for flight acceptance vary by state of the passenger. (See point A.2.7).

a.2.6. Types of passengers

Passengers with diminished capacity are divided for the purposes of aeronautical communications in different classes. These classes are indicated in the messages of airlines by AIRIMP key code such as:

MEDA: Case Medical, those requiring authorization.

STCR: Passenger: Passenger on a stretcher.

WCHR: Wheelchair - R, ramp. The passenger can ascend/descend stairs and navigate to / from your seat to the passenger cabin, but requires wheelchair for long to/from the plane distances; that is, to scroll through ramp, fingers or buses.



a.2.6. Types of passengers

Passengers with diminished capacity are divided for the purposes of aeronautical communications in different classes. These classes are indicated in the messages of airlines by AIRIMP key code such as:

MEDA: Case Medical, those requiring authorization.

STCR: Passenger: Passenger on a stretcher.

WCHR: Wheelchair - R, ramp. The passenger can ascend/descend stairs and navigate to / from your seat to the passenger cabin, but requires wheelchair for long to/from the plane distances; that is, to scroll through ramp, fingers or buses.

WCHS: Wheelchair -S, by steps. The passenger cannot ascend or descend stairs, but can travel to / from his seat in the passenger cabin; requires wheelchair for travel to/from the aircraft or buses and should be raised or lowered by steps.

WCHC: Wheelchair -C, to chair cabinet. The passenger cannot move by itself; requires wheelchair for travel to / from the aircraft / gardener and must be raised and lowered by steps and to / from his seat in the passenger cabin.

BLND: Passenger blind. It may be accompanied by guide dog.

DEAF: deaf Passenger. It may be accompanied by guide dog.



MANUAL DE OPERACIONES
Parte A – General / Básico
 8. Operational Procedures
 8.2 Ground operational instructions
 8.2.2 Aircraft safety operating procedures
 Passangers and cargo

Sección 8.2.2

Review 24

Pág. 7

a.2.7. Categories of passengers and requirements of the Medical Service

a.2.7.1. No Medical Cases. Passengers who do not require authorization for transport and only need special assistance in land and / or by the cabin crew during an emergency evacuation or during flight.

Cat.	Description (1)	Airimp Code	Medial Authori zation	Max.Lim. by aircraft type	Lim. Num. without Acomp.	Required compan ion	Special seat asig.	Group lim
A-1	Passengers with fractures, dislocations, sprains, etc. at a lower or upper limb, with or without plaster and that does not prevent them from moving freely and mentally handicapped able to understand the instructions.	-	NO	NO	NO	NO	NO	NO
A-2	Passengers needing wheelchair for long distances. Elderly, convalescents, etc.	WCHR	NO	NO	NO	NO	NO	NO
A-3	Passengers requiring wheelchairs to access / descend stairs: Passengers hemiplegic. Passengers with amputation, mutilation or defect in one of his legs that can walk by themselves, but they need the help of a cane or crutches. Passengers who cannot bend one of his lower limbs (plaster or not).	WCHR	NO	NO	NO	Yes/NO (4)	NO	NO
A-4	Passengers who need wheelchairs to move to / from the seat of the airplane: paraplegics or quadriplegics Passengers with amputation of both legs, without prosthesis. Passengers who cannot support both lower limbs but can bend the knees (bilateral plasters, sprains, etc).	WCHR	NO	NO	NO	Yes/NO (4)	NO	NO
A-5	Expectant mothers in normal health. According to IATA recommendation is discouraged air travel for pregnant travelers during the 7 prior to the due date and for 7 days after delivery days if complications can be expected in childbirth (2).	-	NO	NO	NO	NO	NO	NO



MANUAL DE OPERACIONES
Parte A – General / Básico
 8. Operational Procedures
 8.2 Ground operational instructions
 8.2.2 Aircraft safety operating procedures
 Passangers and cargo

Sección 8.2.2

Pág. 8

A-6	Deaf, dumb or deaf passengers.	DEAF	NO	NO	NO	Yes/NO (4)	NO	NO
A-7	blind passengers	BLND	NO	SI	SI	Yes/NO (4)	NO	NO
A-8	Mentally disabled, who find it difficult to understand and complete the instructions for a possible emergency evacuation.	-	NO	NO	NO	Yes/NO (4)	NO	NO

(1) Special circumstances can determine their classification into different categories to which you initially appropriate. If in doubt, authorized Optional, will decide in which category included the passenger and what requirements must be completed shall be consulted.

(2) The trip did not recommend according to IATA standards, healthy newborn or premature under seven days.

a.2.7.2. Medical Cases: Passengers requiring special attention, both ashore and on board

Cat.	Description (1)	Airimp Code (2)	Medial Authoriz ation (2)	Max.Li m. by aircraft type	Lim. Num. without Acomp.	Required companion	Special seat asig.	Group lim
B-1	Passengers requiring oxygen supply	YES	YES	YES	-	YES	NO	YES
B-2	Passengers may NOT seated and need to do it on a stretcher.	YES	YES	YES	-	YES	YES	YES
B-3	Premature infants. The incubator will necessarily autonomous rate.	YES	YES	YES	-	YES	NO	YES
B-4	Mentally disabled passengers unable to understand instructions.	YES	YES	YES	-	YES	YES/NO	YES
B-5	Passengers not included in other groups with ill-ties NO contagious, acute or chronic medical or surgical, whose characteristics at the time of flight can be admitted on board the opinion of the authorized doctors, because it is not expected that transport can cause deterioration and death.	YES	YES	YES	-	YES	YES/NO	YES

(1) In case of doubt, authorized physicians, who will decide in which category included the passenger and what requirements must be completed shall be consulted.

(2) The companions will be authorized prescribing physicians.

	MANUAL DE OPERACIONES Parte A – General / Básico 8. Operational Procedures 8.2 Ground operational instructions 8.2.2 Aircraft safety operating procedures Passangers and cargo	Sección 8.2.2
		Review 24
		Pág. 9

a.2.7.3. Cases that cannot be accepted on the fly

Are those who, because of their physical or mental condition, can cause discomfort to other passengers, or are in such serious condition that can cause them a complication or death.

Overall not be accepted on the fly. If in doubt, be authorized doctors will decide on the acceptance or not the fly and requirements. The following cases are distinguished.

CAT	DESCRIPCIÓN
C-1	People whose odors, serious disfigurement, or other unpleasant characteristics are so infrequent that may cause discomfort or distress to other passengers.
C-2	People with infectious diseases.
C-3	People whose behavior can be dangerous to other passengers. Note: If deemed necessary, the intervention of the authorities is required in order to endorse the actions of CLIPPER NATIONAL AIR to any subsequent claim.
C-4	People in such critical condition that the trip can cause them a complication or death.
C-5	All passengers with diminished capacity of the A and B categories that do not meet the requirements thereof and can be detected by staff of shipment, public relations or check at the airport or by the crew to access on board.
C-6	Persons under obvious influence of alcohol, drugs or narcotics

Note: If people insist previously related to travel and / or there is doubt about its acceptability, authorized physicians have to decide on the acceptance and enforceable to the same requirements.

Aircraft type	Total max. number
All fleets	2



a.2.7.3. Cases that cannot be accepted on the fly

a.2.8.2. Maximum number of individual passengers

Traveling without companion

Passengers in categories A-3 / A-4 / A-6 / A-7 and A-8, may travel unaccompanied on number not exceeding those indicated in the following table:

Aircraft type	Total max. number
All fleets	1

Accompanying required

When the number of passengers in categories A mentioned in the previous point is exceeded, the existence of companions sane with the following will be required:

(a) For passengers in categories A-3 / A-4 / A-8, will require a chaperone for every passenger.

The Company, or if necessary the Commander, may require, for reasons of passenger weight or other circumstances, which are two people accompanying order to allow for easier movement.

(b) For passengers in categories A-6 and A-7 (deaf or blind), one person for every two passengers.

The guide dog is considered valid companion of a blind or deaf.

For all classes B, one chaperone for every passenger will always be necessary.

Passengers on a stretcher

The number of passengers on stretchers on board is limited to TWO for CESSNA 550 and ONE for CESSNA 510 for.

	MANUAL DE OPERACIONES Parte A – General / Básico 8. Operational Procedures 8.2 Ground operational instructions 8.2.2 Aircraft safety operating procedures Passangers and cargo	Sección 8.2.2
		Review 33
		Pág. 11

a.2.9. Criteria for allocating seats to passengers in armchair

In the seats with access to the emergency door must be a passenger who can help in the possible evacuation and should never be seated:

- (a) Passenger with a physical or mental disability that prevents him from moving quickly.
- (b) Passengers with sight or hearing problems which prevents them from quickly assimilating written or verbal instructions
- (c) Passenger who cannot move quickly due to their age or illness .
- (d) Passengers who due to their obesity have difficult moving or passing through the door .
- (e) Children accompanied or not.
- (f) Deported passengers, not admitted at destination or in custody
- (g) Passengers whit animals

a.2.10. Allocation of seats for passengers on a stretcher

Will proceed to block the seats to be occupied by the stretcher and those affected by it.

Blocked seats and not occupied by the stretcher, will be assigned to the accompanying passenger on a stretcher.

a.2.11. Passenger handling

In all cases in which passengers are to be transported on a stretcher / wheelchair, and in cases where passengers with diminished capacity not to embark / disembark without assistance, the necessary assistance will be provided by personnel hired handling. Be deemed not after the shipment until the passenger is accommodated by such personnel previously assigned seat, assist in the location of the seat and the best installation on board the passenger.

In cases where Seating obviously not correct, Commander may alter.

If it comes to passengers with reduced capacity can embark / disembark without help, the crew made their accommodation on board seat previously assigned.

a.2.11.1. Actions to be taken at airports

Handling attend to everything related to the transport of passengers with reduced capacity, from the moment that have been accepted until they leave the destination airport.

	MANUAL DE OPERACIONES Parte A – General / Básico 8. Operational Procedures 8.2 Ground operational instructions 8.2.2 Aircraft safety operating procedures Passangers and cargo	Sección 8.2.2
		Review 24
		Pág.12

Origin scale

Land Operations:

Verify that all requirements, limitations (maximum number accepted) and formalities were processed and fulfilled.

You'll notice that the passenger can travel according to the previously agreed terms.

You'll notice that passengers / groups of passengers with diminished capacity accompanied by the person or persons notified and lead the team / specified drugs. Otherwise it will not authorize transportation.

Absence of such a requirement, the possibility to fulfill at or departure to be analyzed. When the timeframe or circumstances do not make it possible, passengers cannot be accepted on the fly.

Will assign / lock the required seats. It shall inform the Commander (Charge Sheet or other printed). You will pass the appropriate information booth. You will embark the passenger / passengers with reduced prior to the remaining passengers capacity. It will send the right message to the scale or scales affected.

Whenever possible, in the case of a passenger traveling with your own folding wheelchair, you can stay in it, and properly labeled to reach the plane and there are stowed in the hold.

Guide dogs specially trained to guide blind and deaf, be accepted for carriage, when accompanying their owners at no additional charge.

The doctors belonging to a specialized patient transport company if they travel alone to meet that sick or in the return flight once the mission is complete, they can carry the bulky and delicate medical equipment in the cabin, with the exception of oxygen.

Transit scale

Handling will have prepared the staff and equipment to perform the landing if necessary.

If passengers need or want to stay on board on a scale transit, given the difficulty of moving by itself, Commander may authorize, permit provided that:

- The safety standards issued by the Company.
- The provisions of local authorities in that respect.
- The rules on refueling with passengers on board.
- Other circumstances.

a.2.11.2. Deviation in flight itinerary

Scale transit or destination

If during flight the plane suffered some deviation in the planned route, the stopover or destination, where the aircraft was due to land IMMEDIATELY send the right message to the alternate airport.

In case of deviation or interruption of service, the Company will provide the necessary assistance for such passengers, but is not obliged to assume expenses and accommodation arising from their status as disabled and exceeding those of other passengers.

	MANUAL DE OPERACIONES Parte A – General / Básico 8. Operational Procedures 8.2 Ground operational instructions 8.2.2 Aircraft safety operating procedures Passangers and cargo	Sección 8.2.2
		Review 24
		Pág.13

Crew

In the case of a flight diverted to an alternate airport where CLIPPER NATIONAL AIR has signed an agreement that airport assistance, Commander may, depending on the content of that agreement, addressed to the Assistant Company and ask her how many aids health or welfare type is required, such as doctors, ambulance services, hospitalization, etc.

As for charges not covered and not paid, therefore, in origin, which may occur, the standards set by our company will be considered.

a.2.11.3. Destination airport

The scale target will be alerted, via message arrival of the passenger with reduced capacity and will be scheduled in advance the necessary services.

These passengers will be disembarked last.

Landing operations shall be conducted by staff for this purpose, using the same means and equipment already described for boarding operations. Once landed the passenger will be escorted to the arrival hall or customs, helping them collect their luggage and the subsequent search for means of transport.

	MANUAL DE OPERACIONES Parte A – General / Básico 8. Operational Procedures 8.2 Ground operational instructions 8.2.2 Aircraft safety operating procedures Passangers and cargo	Sección 8.2.2
		Review 24
		Pág.14

a.2.12. Special or specially chartered flights to transport injured or victims of catastrophic events

In these cases there are no limitations, having the specific instructions received in these circumstances followed.

a.2.13. Performance standards aboard-Normal Operation

Passengers with diminished capacity will be specially catered for by the crew as far as compatible with their flying duties.

Onboard location

It is important that the (rigid or telescopic) and crutches used by persons with diminished capacity, canes are stowed in the right place. It has been shown that the use of these elements during emergency evacuation has obstructed the output of the users rather than speed. Moreover, the possibility of accidental fall of these elements in a corridor may obstruct or block it completely.

Instructions before takeoff

In general, passengers with reduced capacity no problems in this regard. The instructions and demonstrations are also valid for these passengers; those which by their nature require, will be instructed individually, taking into account their particular circumstances.

The crew is responsible for giving the accompanying passenger groups with diminished capacity, the following instructions:

It will signal the status of the nearest emergency exit. It

will indicate the status of the rafts and life jackets.

It will give each person a booklet "Safety Instructions".

It will ask accompanying the study and to ask any further information they need.

The forms will be collected and stored in place in order to prevent loss.

A.2.14 Emergency Operation

Evacuation

- (a) Passengers with reduced individual capacity.

In an emergency, evacuation of passengers with reduced capacity, will be performed as safely and expeditiously as possible, without incurring delay, or more slowly in the evacuation of the remaining passengers

	MANUAL DE OPERACIONES Parte A – General / Básico 8. Operational Procedures 8.2 Ground operational instructions 8.2.2 Aircraft safety operating procedures Passangers and cargo	Sección 8.2.2
		Review 24
		Pág.15

a.2.15. Passengers affected by incidents / accidents on land

If after accepting the flight, passenger suffers any illness, accident, injury, injury or aggravation of his illness, for initiation or continuation transportation thereof shall be issued in the form below.

a.2.15.1. The passenger seems airworthy and want to start

Handling consult with the Medical Service of the airport and submit the case for consideration of Commander.

a.2.15.2. The passenger does not seem able to travel

Handling consult with the Medical Service of the airport and submit the case for consideration of Commander.

a.2.15.3. Injuries or accidents occurring on board

In the event that a passenger had agreed to transport under passenger / sick / decreased from escalating while on board the aircraft in flight, the commander may decide to land at the nearest suitable airport depending on the severity of I event.

	MANUAL DE OPERACIONES Parte A – General / Básico 8. Operational Procedures 8.2 Ground operational instructions 8.2.2 Aircraft safety operating procedures Passangers and cargo	Sección 8.2.2
		Review 24
		Pág.16

a.3 Transportation destination inadmissible passengers, deportees or persons in custody

These passengers are comprised mainly of the following groups:

- Non admitted persons
- Deportees
- Condemned Prisoners and Extradition Subjects. The rules for these travelers are described below, taking into account that they are always subject to country ordering the deporting of the passenger.

a.3.1. Non Admitted Passenger (inadmissible Passenger, INAD)

According to IATA Resolution 701, passengers are from a different nation from that of the arrival airport, and who are not supported by the Competent Authority nationality. The usual reasons for non-acceptance are:

- Defects in the documentation of the passage
- Immigration Authorities deciding that the passenger is not acceptable.

If any of the passengers of the Company is not accepted at the destination, they will return to the departure airport on the same plane.

This non-acceptance will be communicated to the pilot.

a.3.2. Deportees (Deportees, DEPO)

According to IATA Resolution 701, is a person who has been lawfully admitted to a country by its authorities or who had entered the country illegally, and that subsequently those authorities formally ordered their exit.

a.3.3. Transport Limitations

Given the characteristics of the aircraft used by the Company, except by the order of the competent authority, deported passengers, convicted, prisoners and/or passengers subject to extradition due to their potential danger, shall not be allowed to board

	MANUAL DE OPERACIONES Parte A – General / Básico 8. Operational Procedures 8.2 Ground operational instructions 8.2.2 Aircraft safety operating procedures Passangers and cargo	Sección 8.2.2
		Review 32
		Pág. 17

8.2.2.b PERMITTED SIZE AND WEIGHT OF HAND LUGGAGE

- **Classification and definition.**

The dimensions of the package shall not exceed 50x40x20 cms so that no package will have dimensions + length + width exceeding 110 cm tall and weighs 6 kg.

In no event should the location of cabin baggage hinder access to emergency exits or the sight of the cabin crew on the passageway.

- Limitation on number of pieces, weight and size. Passengers may carry luggage with the measures described above, a handbag and an overcoat
- Hand luggage exceeding the measures accepted: handling personnel are initially responsible for monitoring the size of luggage. Later the crew will check again that there is no package board that exceeds the measures described above.
- Packages exceeding these measurements or weights will be placed in the hold.
- In the absence of pressurized aircraft cargo holds, companion animals (dogs and cats) must be carried in the passenger cabin together with their owners. The animals must be more than 3 months old, have veterinary passport, identification system and in the case that they weigh more than 8 kg they should travel inside a cage.

	MANUAL DE OPERACIONES Parte A – General / Básico 8. Operational Procedures 8.2 Ground operational instructions 8.2.2 Aircraft safety operating procedures Passangers and cargo	Sección 8.2.2
		Review 24
		Pág.18

8.2.2.c LOADING AND FIXING OF ARTICLES ON THE PLANE

Cargo compartments of the Aircraft Company are not accessible to the crew during the flight, they are not pressurized and do not have any warning system to the cabin.

c.1. Passenger cabin.

To ensure that the luggage and packages are properly positioned, the following measures should be taken into account:

- Each item carried in cabin must be placed only in a place that is able to sustain them;
- Not baggage is to be placed under the seats.
- There should be no items placed in toilets or by bulkheads.
- Luggage and packages are not placed where they can impede access to emergency equipment; and
- The co-pilot, before takeoff and landing, will ensure that the luggage is placed where it will not impede evacuation or could cause injury (from a fall or other movement).

c.2. The Hold.

- Care should be taken with the doors during loading and unloading.
- Precautions must be taken when maneuvering heavy or bulky goods within the hold to prevent damage to the floor.
- When liquids are spilled in the hold, this shall be communicated immediately to prevent damage to the floor or electrical wiring.
- Will drop any packet is immediately labeled as dangerous goods.
- They shall proceed with caution when damaged baggage is detected. Such packages shall not be transported, as they are a potential source of danger.
- Once the baggage is loaded a visual inspection will be made to ensure that the networks and / or anchors are placed, secure and prior to departure of the aircraft the hold door is closed.

	MANUAL DE OPERACIONES Parte A – General / Básico 8. Operational Procedures 8.2 Ground operational instructions 8.2.2 Aircraft safety operating procedures Passangers and cargo	Sección 8.2.2
		Review 24
		Pág.19

8.2.2.d. POSITION OF GROUND STAFF

Mobile teams that normally approach the plane are:

- Passenger Van
- Stewardship Van
- Handling van
- GPU
- Waste disposal
- Push Back

The responsibility for management rests with the handling that meets the plane

The mobile ground equipment, operated only by personnel of the Company or properly trained handling agents, will not approach the aircraft until all engines have stopped (anti-collision lights off) and chocks are placed, or if they have the authority of the pilot. The speed of the equipment will always be reduced: If an engine should remain in operation, the mobile equipment will approach the plane on the side with the engine turned off. In all cases the flight crew and ground staff should have previously agreed on the steps to follow.

There should always be a distance left between the ground crew and the aircraft to avoid possible damage caused by displacement of a surface plane during loading / unloading / refueling, etc.

The ground crew should not enter the areas dedicated to the taxiing of the aircraft and boarding / disembarkation of passengers.

	MANUAL DE OPERACIONES Parte A – General / Básico 8. Operational Procedures 8.2 Ground operational instructions 8.2.2 Aircraft safety operating procedures Passangers and cargo	Sección 8.2.2
		Review 24
		Pág.20

8.2.2.e OPERATION OF THE GATES OF PLANE

The opening and closing of the door of the passenger cabin will be made after the approval of the pilot.

Both the passenger door and the hold cannot be opened open until the motors are turned off and chocks in place. They should be closed prior to engine start.

The passenger door may remain open, with the right engine running, to allow conditioning of the cabin. It should lock , when passengers will be on board, before starting left engine.

They are handled by the crew inside. In case of emergency they can be opened from the outside.

The doors of all the aircrafts of the Company are handled in the same way:

To open: Turn the lever in a clockwise direction and push out

To close: Close the door and turn the handle counterclockwise to clockwise.

The tanks are positioned so that:

- i) They do not obstruct access to the aircraft for emergency and / or firefighting vehicles
- ii) Maintain a clear exit if they have to get away quickly in the case of an emergency. Loading / unloading is interrupted when a vehicle obstructs emergency evacuation route of tank vehicles.
- iii) Do not obstruct the evacuation of the aircraft in case of fire on board.
- iv) The engines of such vehicles are not under the wings of the plane.

Vehicles used for various operations other than loading / unloading fuel shall comply with the provisions above. They must be positioned so as not to impede the operation of firefighting vehicles, or the exit of fuel tanks.

Exhausts for all vehicles having to operate in the charge / discharge must be carefully maintained to eliminate elements that may produce sparks or flames capable of igniting fuel or vapors.

The auxiliary power units of land and / or airborne (APU), will connect and will be launched before the start of supply and will not stop or be disconnected until it has finished loading / unloading.

8.2.2.f SECURITY IN THE RAMP AND SUCTION JET AREAS, INCLUDING FIRE PREVENTION

All personnel performing their work on the ramp shall wear a reflective vest and exercise caution when using mobile equipment.

When the ground crew is addressed or abandon the aircraft should not be driven at a speed higher than the passage of a person.

Before moving a ground crew around the aircraft inspection is conducted and verified to be free of FOD's.

	MANUAL DE OPERACIONES Parte A – General / Básico 8. Operational Procedures 8.2 Ground operational instructions 8.2.2 Aircraft safety operating procedures Passangers and cargo	Sección 8.2.2
		Review 24
		Pág. 21

By placing a computer, special care should be taken to ensure adequate clearance of vehicles, aircraft, or other equipment

When vision is limited in critical areas a person will guide the operation.

Standard hand signals are used to guide the ground crew.

The guide is located so that it can accurately judge the available space is visible and able to communicate signals at all times the vehicle operator. This will stop immediately if lost visual contact with the guide.

The power equipment should check brakes before entering a restricted area and again before getting off the plane.

Vehicles with protective rubber bumpers not compressed against the aircraft fuselage to prevent damage to it.

All equipment except the need for output, will step behind the restraining line before starting the aircraft pushback.

In an area of open outlet, the team placed so that there is enough space for movement of aircraft.

f.1. FIRE PREVENTION IN DANGER ZONES OF COMBUSTION AND AREAS OF FILLING.

Fire prevention is more important than fighting the fire. The following considerations to prevent and protect against fire will be considered:

- The accumulation of garbage is not allowed, unless it is in proper containers.
- They will immediately report any suspicion or knowledge of the existence of fire.
- They will immediately report any failure in the electrical wiring.
- Smoking is not permitted on the ramps or in any vehicle on ramps.
- The location of fire fighting equipment, fire alarms, emergency switches, etc. should be known by the staff.
- Access to fire fighting equipment, fire alarms, emergency switches, etc. will not be obstructed.
- If fire is observed in a parked aircraft it will be communicated immediately to people inside and their evacuation will take place.
- While the fire is controlled, if there is any doubt about the safety of personnel, any extinguishing equipment belonging to the ground team or on the aircraft may be used.
- If possible, the aircraft doors should be closed.
- If fire occurs in ground equipment supporting the aircraft it will be fought using extinguishers that are on the ramp or those belonging to the ground equipment itself. As soon as possible, ground equipment will be removed from the vicinity of the aircraft.
- No ground equipment will operate in the vicinity of a fuel spill.
- The staff should know the types of equipment available for firefighting, and will be trained in its use.

f.2. PRECAUTIONS IN AREAS OF JET AND SUCTION



Maximum precautions should be taken by ground staff on the ramp while the engines are running in these areas under influence of the reactors.

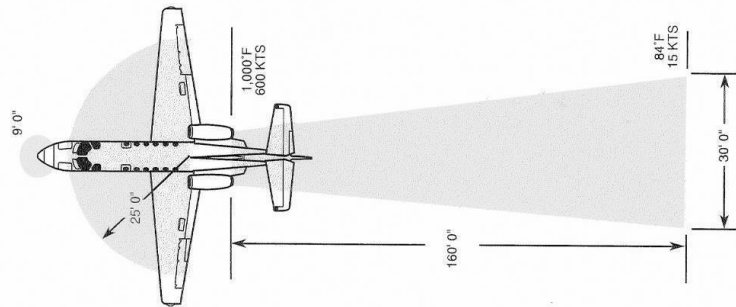

8.2.2.g. PROCEDURES FOR THE TURNING ON OF THE AIRCRAFT, THE REMOVAL OF THE RAMP AND ARRIVAL INCLUDING PUSHBACK OPERATIONS AND TRAILER

The auxiliary power unit or ground equipment will be used as an energy source on the ground before the launch.

If these units were not working, they will be started with a battery as defined in Section 3 of the AFM and the QRH (start with battery)

g.1. Start up.

The start up of the motors may be hazardous to ground personnel and objects near the aircraft.

The pilot will consider the departure time slot and other related factors, when starting the engines.

Before the launch, the pilot will ensure the jump leads are on board and the start up area is free.

g.2. Ramp removal procedure.

Before taxiing begins, they need to have the proper authorization from the control tower and ground personnel must ensure area is free and unobstructed.

	MANUAL DE OPERACIONES Parte A – General / Básico 8. Operational Procedures 8.2 Ground operational instructions 8.2.2 Aircraft safety operating procedures Passangers and cargo	Sección 8.2.2
		Review 24
		Pág. 23

The pilot shall notify Handling that they are is ready to start with brake signal posts and Beacon On.

Handling personnel should remove the brakes and once the plane has started up they should also remove the GPU equipment. They should check the area is unobstructed and send a signal plane that the plane is ready to start up.

When you start shooting the commander must judge the situation around the aircraft, especially near other aircraft and objects, carrying a suitable rate of shoot and a power that does not cause excessive noise; particularly to start shooting from the car park.

The commander is responsible for ensuring that the aircraft does not make contact with any object while performing maneuvers with engine power.

The signal "free tickets" will be given by the ground crew before starting the shoot.

The taxi lights will be activated once the signal obtained "free tickets", before removing the brakes and start shooting.

It is very important that all members of the flight crew to shoot tuned especially when conditions are unfavorable, for example, low visibility, unfamiliar airport, etc. Reading checklists will not start or continue as conditions exist that require special attention.

When in doubt about the position at the airport, the aircraft will be stopped immediately and inform ATC or track control.

They should follow signs to the strictly surface. Stop lights shall not be exceeded.

Filming lines vary from place to place and do not always ensure freedom from obstacles. Will be used with caution as guide the plane.

The commander, when signs posted on the ramps is guided, is responsible for maneuvering the aircraft.

Towing and push back Procedures

If it is necessary to push-back proceed as follows:

- 1) towing crew, with aircraft with brakes set or wheel chocks placed at the main gear wheels to prevent aircraft backwards movement, enter ramp of the equipment under nose-wheel of aircraft and fixed by a pin
- 2) notifies the Commander " chocks out and release parking brake. "
- 3) moved the aircraft to the point of departure, stop and warns put brakes before removing the nose-wheel ramp and take tow vehicle

Authority to taxi the aircraft

CLIPPER NATIONAL AIR aircrafts will taxi in the movement area of an aerodrome always handled by members of the flight crew, unless the person at the controls:

1) has been duly authorized by CLIPPER) or is a designated agent and is able to:

- i) taxi the airplane
- ii) use the radio telephone and

2) has received instruction with respect to the aerodrome layout, taxiways, signs, markings, lights, instructions for air traffic control, phraseology and procedures, and can follow the practical arrangements for the safe movement of aircraft for the aerodrome.

	MANUAL DE OPERACIONES Parte A – General / Básico 8. Operational Procedures 8.2 Ground operational instructions 8.2.2 Aircraft safety operating procedures Passangers and cargo	Sección 8.2.2
		Review 38
		Pág. 24

g.3. Arrival procedures.

With the aircraft stopped engines and beacon off, the pilot will send the chocks signal. Handling staff position them and signal for the pilot to remove the brakes and order the opening of the doors.

The number of chocks and their placement figure in point 8.2.2 of this section.

g.4 Parked Plane

When an aircraft is parked, the main wheels have the chocks in place.

8.2.2.h. AIRCRAFT MAINTENANCE MINOR

Commander must request to Handling that serve sit, needed services, suchas:

- De-icing/anti-icing
- maintenancerecare
- fuel
- catering
- oxygen
- cleaning,etc

These services willbeoverseenbycrewmemberandbilledbyhandling,withintermsof contract that has with company and that provides for this possibility

8.2.2.i DOCUMENTS AND FORMS FOR THE HANDLING OF AIRCRAFT

General information

Reports, forms, and in general, all documentation, will be written with pen (with very clear, preferably up percase letter)and, whererequired,willbesigned.

Unless specified to contrary, date will be day whose start time leongs, and GMT time. Each stage of a flights series, is considered as individual flight.

Following document sand forms are required for realization of operations on land:

-Load sheet. flight dispatchers will provide it, the data must match those of the PVO.

Must be approved by the pilot in command

-LIR,Handling realizes it, firmand deliver sit to Commander

-Cargo manifest Handling will fill in each flight cargo manifest. A copy will be given to Commander for inclusion envelope of flight operations for return to land.

Thismanifestmustbeissuedevenifitisnotcarryingcargo

Number of passengers and/or kg of cargo indicated in cargo manifest must be same as those indicated in loads heet.

	MANUAL DE OPERACIONES Parte A – General / Básico 8. Operational Procedures 8.2 Ground operational instructions 8.2.2 Aircraft safety operating procedures Passangers and cargo	Sección 8.2.2
		Review 38
		Pág. 25

- **NOTOC**, handling communication to the pilot in command, when a special cargo is transported.

- **Fuel sheet**, responsible for supply realizes it. Commander with his signature on the delivery note records its Checked. Commander will keep receipt which will include in envelope of flight .

- **List of passengers**, Handling realizes it, signature and delivered to the Commander.

- **Disclaimers**. Handling realizes it, signature by the person in charge of the passenger and delivered to the Commander by handling.

- **Security lists** Once passengers disembarked and unloading baggage/load shall will complete corresponding personnel lists described in safety procedures.

Conservation policy of documents operation flight, formation and qualifications of personnel related the operation of assistance in ground is specified in the chapter A2 of this OM.

8.2.2.j SPECIAL CARGO AND CLASSIFICATION OF THE CARGO COMPARTMENT.

When special loads are carried, the ROV shall inform to handling that attend aircraft and this in turn inform the Commander.

The report is included in envelope containing all documentation of flight and crew at the end of their service deliver this to central office of Company in Barcelona.

Special loads are considered

PERISHABLE goods

All goods to be transported without delay, otherwise is perishable, loses its utility, and therefore its value, by having to be delivered within a certain period, either because it may deteriorate due to changes of temperature and humidity and the passage of time

Examples of perishable goods are:

- food such as: meat, fish, fruit and vegetables, flowers

Humans remains

Company will accept to transport human remains (HUM) subject to following restrictions:

1. A except for human remains incinerated, must be contained in a coffin inside of lead or zinc hermetically sealed inside a wooden coffin.
The coffin of wood must be protected by a canvas outer packaging in such a way that its content is not evident.
2. In a case of cremated remains must be contained in urns protected against breakage with appropriate packaging.
3. Must be handled with respect and keep them covered during their loading and unloading.
4. Will be not transported in same holds to any perishable goods.
5. The Commander shall be informed through a NOTOC about presence of human remains, weight and location of the coffin

Human remains will not be accepted unless relevant documentation is attached to the coffin or casket



Compatibility between perishable goods and human remains

Following table shows different perishable goods or human remains that may be loaded together in the holds, and those that do not.

<u>Type</u>	MEAT	SEAFOOD	FRUIT & VEGETABLES	FLOWERS	HUM
MEAT	☑	☑	☑	☑	✗
SEA FOOD	☑	☑	☑	☑	✗
FRUIT & VEGETABLES	☑	☑	☑	✗	✗
FLOWERS	☑	☑	✗	☑	✗
HUM	✗	✗	✗	✗	☑

NON-perishable goods

Is non-perishable goods, all goods that does not run the risk of losing its usefulness or value if transport system with delay

Spare parts for aircraft, company and email (non-dangerous goods)

CO-MAIL = mail of the company

CO-MAT = material of the company

Mail and material of company means internal shipments of mail and material, such as documents, inventory, maintenance parts and supplies for cleaning or other items that need to be delivered to company or contracted company to perform a particular service (e.g.: cleaning company).

Both internal mail and company material carried on aircraft of the company will be subject to security checks before being shipped.

The company must ensure that any shipping co-mail or co-mat done in his name by a contracted company is inspected before being loaded on the aircraft.

All requests for spare parts for aircraft transport must come from company maintenance department. Transport CO-Mail and spare parts is allowed on aircraft, subject to space and weight restrictions.

NOTOC form, which includes relevant information shall be completed and will be sent by mail to Handling hired at airport of departure

The NOTOC provides a description of piece, its size and weight, in addition to a declaration of non-dangerous goods.

It is responsibility of handling agent to make sure NOTOC is completed before allowing burden of piece. Handling agent must ensure that LIR and load sheet display properly weight of load and its position.



Maintenance will ensure that spare parts have been carried to aircraft, which have been properly protected and have been added a label of "spare".

Mail

Company accepts and carries commercial mail or packages

Wheelchairs

Given the size of the holds's door can only be transporting folding wheelchairs

Live animals (AVIS)

Animals can travel in cabin of passage whenever it will not disturb therest of passage In any case they shall always be tied down or lashed and carry appropriate certificate document is provided by cargo agent.

Animals (dogs and cats) must be transported in company of their owners.

They should have more than 3 months old , have veterinary passport and identification system. Live animals will have to go in kennel and its permissible maximum weight is 8 Kg.

Will be considered wet goods and floor of kennel will be covered by absorbent material. More than 2 animals must not be transported in cabin.

a) Refrigerators with organs for transplant.

These refrigerators must be in the cab of passage, the cargo compartments not be pressurized Surgical team will be transported on them. They are specially chartered flights

j.1. Classification of cargo compartments

Cargo compartments are classified according to their accessibility during the flight, the possibility of being isolated with respect to ventilation and the type of fire extinguishing system which may arise inside.

The company airplanes have the following compartments, unpressurized:

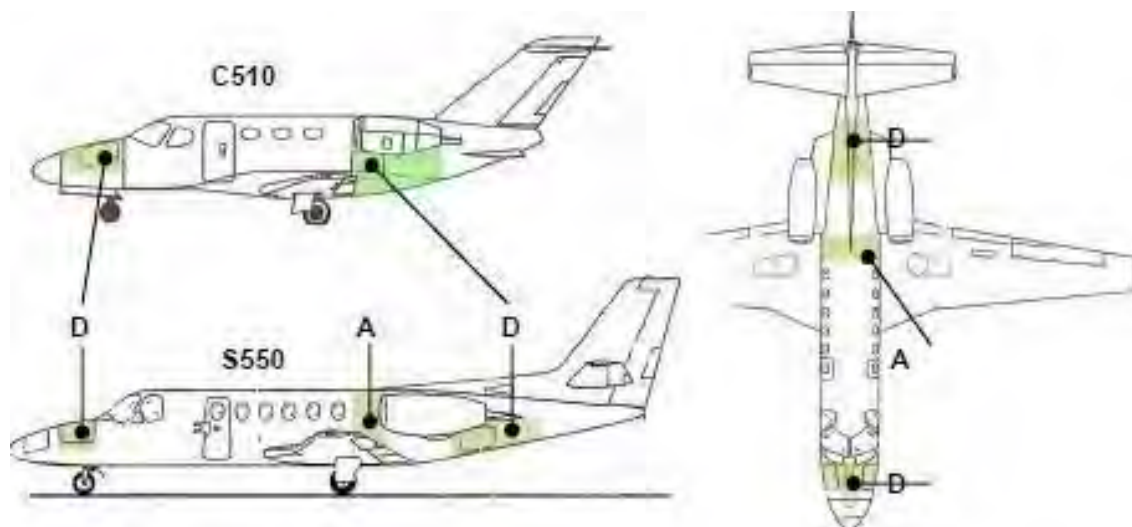

	MANUAL DE OPERACIONES Parte A – General / Básico 8. Operational Procedures 8.2 Ground operational instructions 8.2.2 Aircraft safety operating procedures Passangers and cargo	Sección 8.2.2
		Review 24
		Pág. 28

Cargo compartments of aircraft of the Company are neither pressurized or vented and feature fire warnings and nor are accessible from the cockpit.

CESSNA 510

Loading data in weight, volume and soil resistance shown in Chapter 1 OM.

CESSNA 550

As contained in the Manual WB 1-60-00 Page 1, has three cargo compartments with a resistance of 120 pounds per square foot.

The first NOSE has a capacity of 350 pounds in an area of 19 cubic feet

The second AFTER CABIN has a capacity of 800 pounds in an area of 36 cubic feet

The third TAIL CONE has a capacity of 200 pounds in an area of 11 cubic feet.

Given the dimensions of the cargo, only can carry folding chairs.

8.2.2.k. MULTIPLE OCCUPATION SEATING PLANE.

Multiple occupancy of airplane seats so passengers per crew is prohibited.

Multiple occupancy of seats is only allowed when an occupant is an adult and the other a baby.

	OPERATIONAL MANUAL Part A – General / Basic 8. Operational Procedures 8.2 Ground operational instructions 8.2.3 Procedures for denying boarding	Section 8.2.3
		Review 24
		Page 1

8.2.3 Procedures for denying boarding

The company will not permit any person to enter under the influence of alcohol or drugs, so that may affect the safety of the aircraft or its occupants.

Before taking flight, Commander is empowered to prevent the embarkation of passengers which are under the influence of alcohol, drugs, etc., and that could be dangerous or annoying for the rest of the passage. The Commander may request advice from the medical staff of the airport before making a decision of this type.

These points do not apply to patients undergoing medical care and who have their statement of release and / or the corresponding physician company.

	OPERATIONAL MANUAL Part A – General / Basic 8. Operational Procedures 8.2 Ground operational instructions 8.2.4 Elimination and prevention of ice on the ground	Section 8.2.4
		Review 30
		Page 1

8.2.4 Elimination and prevention of ice on the ground

The applicable procedures are set out in AFM and / or OM of each type of aircraft for Special Operations and Operations Cold Time.

Considerations to take into account in assessing the icing of aircraft

- (1) It is necessary to have a clear idea of the adverse effects of roughness on the outer surface of the airplane under actuation.
- (2) It is advisable to request anti-ice services without knowing the procedures and products used in them.
- (3) It is necessary to know the most critical aircraft in icing, to be properly treated in order to prevent possible damage to the anti-ice operations and to be duly considered in the pre-flight inspection areas.
- (4) If deemed appropriate, should be no hesitation to perform additional pre-flight inspections.
- (5) There are several variables that affect the effectiveness of anti-ice liquids.
- (6) Cannot be determined with absolute accuracy the time of effectiveness of anti-ice liquids, being many variables that affect this time.
- (7) The anti-ice treatment should be as close as possible to the time of takeoff.
- (8) Engines should not be started if there are fragments of ice on the surface that can be ingested.
- (9) Certain operations may produce recirculation of ice crystals, snow or ice and water mixture.
- (10) The operation of some equipment in the vicinity of the aircraft can facilitate the accumulation of snow or ice in critical areas.
- (11) It is recommended during filming examine the possible accumulation of ice in the profiles.
- (12) Immediately before starting the takeoff should be a final visual inspection from the cockpit. Do not start off if you cannot make cleaning the plane.



DESCRIPTION OF TYPES AND EFFECTS OF ICE AND OTHER POLLUTANTS

Rain and Snow: Rain and mixed precipitation in the form of rain and snow. For purposes of HOT it should be considered as freezing drizzle.

Antifreeze: Procedure to prevent the formation of ice and frost, or the accumulation of sleet, snow or slush on clean surfaces of the aircraft, for a limited period of time.

Testing: Inspection of an element by trained and qualified personnel.

Checking pollution: Inspection of the surfaces of an aircraft to determine the need for de-icing.

Pollution: Any kind of frozen or semi-frozen as frost, snow or sleet moisture.

De-ice: A procedure in which frost, ice or sleet snow is removed from aircraft surfaces leaving them free.

De-icing / Anti-icing: A combination of procedures for de-icing and anti-icing. It can be performed in one or two stages.

Anti-icing in one stage: Procedure is performed using an antifreeze fluid that has been heated above specifically. This fluid is used to thaw the aircraft, said fluid remains on the surface forming a frost film.

Anti-icing in two stages: This procedure comprises two distinct stages. At first, the thawing of the frost will follow, both entirely different and that two different fluids are used. The anti-icing fluid is applied sprayed to protect critical surfaces of the aircraft, and the procedure that provides maximum antifreeze.

Effect of wet cold (cold-soak effect): It is said that airplane wings are soaked and cold, when they contain very cold fuel on landing as a result of high altitude flight or has refueled the plane with fuel very cold.

When there is precipitation over these supercooled areas on the ground, glass gall (clear ice) is may be formed. Although the OAT is between -2° and $+15^{\circ}$, ice or frost may form in the presence of visible moisture or high humidity if the airframe remains at 0 or below. The vitreous ice is very difficult to detect visually and can break during or after takeoff. Factors contributing to the super-cooling are, the temperature and amount of fuel in the tanks, the type and location of these deposits, the amount of time flying at high altitudes, temperature and type of fuel since the type refueled.

Frost: Ice crystals are formed from air-saturated ice at temperatures below 0° by direct sublimation on the ground or other objects.

Note: The de-icing fluids are normally applied hot to ensure maximum effectiveness.

**OPERATIONAL MANUAL****Part A – General / Basic****8. Operational Procedures****8.2 Ground operational instructions****8.2.4 Elimination and prevention of ice on the ground**

Section 8.2.4

Review 34

Page 3

Ice pellets (ice pellets): Precipitation of small pieces of ice transparent or translucent bottom diameter of 5 mm.

Hail: Precipitation of small balls or pieces of ice with a diameter between 5 mm and 50 mm, falling either separately or together.

Crystalline ice: Ice Sheet, usually smooth and glassy, but with airbags, which is formed in the objects that are exposed to temperatures below or slightly above freezing, and is due to icing drops water, drizzle or rain drops of super cooled.

Amorphous ice: Ice type produced by engelantes or super cooled mists. Has a porous and opaque granular texture, sometimes has crystal formations.

Freezing rain: precipitation in the form of very fine water droplets and close together that freeze on contact with any surface.

Freezing Fog: Set visible water droplets in suspension which freeze as contact with any object outdoors, usually reduces the horizontal visibility to less than 1 km.

Snow: Precipitation of ice crystals, most of which fall in the form of six-pointed stars. These crystals may be isolated, or together form called snowflakes.

Muddy snow: Snow saturated with water splashing in which contact occurs.

Wet snow: Snow formed when the ambient temperature is near or above freezing.

Dry snow: Snow formed when the ambient temperature is below or well below freezing

Runway Contaminated by compacted snow: The runway is covered by pressed snow forming a solid mass. The wheels of the aircraft leave little rolling.

Runway Contaminated by wet snow: The runway is covered by snow that when compacted in the hand release a large amount of water.

Runway Contaminated by dry snow: The runway is covered by fresh snow that when compacted in the hand does not release water.

Runway Contaminated by standing water: The runway has puddles of water with a depth greater than 3 millimeters in more than 25% of its length.

Runway Contaminated by Slush: the runway is covered by ice or snow in melts with a large amount of water it cannot be compacted by hand

Runway Contaminated by dry ice or wet ice: the runway is freezing and the surface is very slippery

Light rain: precipitation of less than 0.2 mm in 6 minutes. In the rain, the individual drops are identifiable and not completely wet the exposed surface. In snow and rain, visibility is greater than 800 m.

Moderate rain: Precipitation between 0.2 and 0.7 mm in 6 minutes. In the rain, you cannot identify individual drops and splashing be seen a few inches off the ground. In snow and rain, visibility is greater than 400 m (1/4 statute mile) but less than or equal to 800 m.

Strong Precipitation: Precipitation over 0.7 mm in 6 minutes. The rain seems to fall into mantle and splatter rises several centimeters from the surface, can be spray and visibility is very low. In snow and rain, visibility is less than 400 m.



OPERATIONAL MANUAL

Part A – General / Basic

8. Operational Procedures

8.2 Ground operational instructions

8.2.4 Elimination and prevention of ice on the ground

Section 8.2.4

Review 34

Page 4

Holdover time (Hold Over Time, HOT): Maximum time estimated the antifreeze fluid maintains its properties, avoiding the formation of ice and frost and the accumulation of snow and sleet on the surfaces of the aircraft it is protecting.

a) COMERCIAL NAMES

Trade names and anti-icing fluids, as types are:

- In Type I fluids the most common are:

Hoechst: Safewing DG I and MP I Safewing

Kilfrost: DF

BASF: Aerex 102

- In Type II and III fluids

Hoechst: Safewing MP II

Kilfrost: ABC-3

UCAR: AAF ULTRA

- In Type IV

Hoechst: Safewing MP IV

UCAR: AAF ULTRA PLUS

B) FEATURES

Fluid Type I

It has a high content of glycol and a very low viscosity, since it does not contain thickeners. Which makes its capacity as anti-ice is very limited.

It is mainly used to remove ice, snow or slush from the surface of the aircraft before the start, spraying it, alone or mixed with water, at a temperature between 70 and 80 degrees centigrade and at a distance of about three meters.

It does not alter the performance of the aircraft, and if atmospheric conditions allow a holdover that covers the time between the application of the fluid and the expected time of takeoff its use is the preferred option (See Annex II to the MOA).



Fluid Type II, III and IV.

It is normally used as anti-ice to ensure that the aircraft stays clean from its thaw until the scheduled time of takeoff.

The weather conditions and the expected time between de-icing and take-off, condition the type of fluid and its concentration (Refer to the Holdover tables of the Annex II to the MOA)

They are sprayed cold on the surface of the aircraft about three minutes after have been cleaned and are not compatible with each other, so they can not be mixed.

Its high viscosity reduces the performance of the aircraft and forces its revision and cleaning, normally every three applications.

In case of not having Type I Fluid, they can be used to effect the thawing following the same procedure.

They are listed below, along with the details of the lowest temperatures at that the different possibilities can be applied to the surfaces of the For type II, III and IV fluids as protection against ice

in a single operation step, or as a second step in a two-step operation.

Concentration of the mixture (Fluid/Water) % vol	Lower Temperature limit For Application (OAT)
50/50	-3°C
75/25	-14°C
100/0	-25°C



C. EFFECTS ON THE PERFORMANCE OF PLANE

The commander shall not commence take-off unless the external surfaces are clear of any deposit which might adversely affect the performance and / or controllability of the aircraft

TAKEOFF PERFORMANCE – TYPE II, TYPE III, AND TYPE IV FLUIDS

MODEL C-S550

Takeoff performance is degraded when Type II, Type III, or Type IV anti-ice fluid is on the airplane.

The fluid that remains on the airplane during takeoff causes the elevator forces at rotation to be increased and the takeoff distance to be increased.

It is recommended takeoffs use the Flaps T.O. (7°) position and takeoff field length be increased as follows when Type II, Type III, or Type IV anti-ice fluid has been applied to the airplane.

Determine the normal Flaps T.O. (7°) takeoff field length and apply adjustments to speed and field length required by runway gradients or runway contamination. Multiply the resulting takeoff field length by the appropriate factor from the following table to determine the takeoff field length when Type II, Type III, or Type IV anti-ice fluid is on the airplane.

FLAPS T.O TAKEOFF FIELD LENGTH	FACTOR
Dry Runway	1.15
Wet Runway	1.15
Contaminated Runway	1.15

CAUTION

- Anticipate a heavier than normal elevator force at rotation. Even with the increased pull force, the airplane may rotate slower than normal. The elevator forces will return to normal shortly after liftoff.

The 1.15 correction factor is approximate. Actual conditions may require distances greater than those determined.



MODEL C-510

Takeoff and climb performance is degraded when Types II, III, and IV fluids are on the airplane. The fluid that remains on the airplane after takeoff causes the elevator forces at rotation to be increased, takeoff distance to be increased, and climb performance to be decreased.

The following procedures are recommended when departing with anti-ice fluid on the airplane.

1. Use Flaps UP.
2. Anticipate a heavier than normal elevator force at rotation.
3. Determine the normal Flaps Up takeoff field length, and apply any adjustments to speed and field length required by runway gradients or runway contamination from the basic FAA Approved Airplane Flight Manual. Multiply the takeoff field length by 1.25.
4. Decrease the First or Second Segment Takeoff Net Climb Gradient by the appropriate delta from the tables below.

For weights greater than or equal to 7500 lbs:

Takeoff Net Climb Gradient Adjustment – Type II, III, or IV Fluid					
Climb Segment	Wind				
	-10 kts	0 kts	10 kts	20 kts	30 kts
First Segment	-1.8	-2.1	-2.1	-2.3	-2.5
Second Segment	-1.8	-2.0	-2.1	-2.2	-2.3

For weights less than 7500 lbs:

Takeoff Net Climb Gradient Adjustment – Type II, III, or IV Fluid					
Climb Segment	Wind				
	-10 kts	0 kts	10 kts	20 kts	30 kts
First Segment	-2.2	-2.4	-2.6	-2.7	-2.9
Second Segment	-2.0	-2.3	-2.4	-2.6	-2.7

5. Multiply the Single-Engine Takeoff Flight Path Distances by 1.3.

NOTE

Flaps 15° takeoff with Types II, III, or IV fluid applied are prohibited per limitation in Section II.

	OPERATIONAL MANUAL Part A – General / Basic 8. Operational Procedures 8.2 Ground operational instructions 8.2.4 Elimination and prevention of ice on the ground	Section 8.2.4
		Review 34
		Page 8

d) EFFECTIVE TIME

The estimated time during which an antifreeze fluid will prevent the formation of frost or ice and accumulation of snow on the protected surfaces of an aircraft, depends on the type of fluid used, its concentration, the temperature outside environment and weather conditions and existing precipitation.

These times are established in the Holdover tables found in the Annex II to the MOA and are renewed annually, collecting progress and improvements in the fluids used.

e) PRECAUTIONS DURING USE

These fluids are toxic, avoid breathing them during application and avoid contact with eyes or skin.

Do not spray directly into pitot and static, windows, air conditioning vents or the cockpit windshield.

f) **Deicing/anti ice procedures in the aircraft.**

- 1) Carefully plan on ground deicing procedures with reference to the above recommendation tables to ensure that materials are available and suitable according to the weather forecast and conditions that have been assigned and understood. This should include a security service provider that, in the event that the pilot cannot verify, the supplier complies with standards of satisfactory quality in terms of procedures and facilities used.
- 2) Ensure that the concentrations of fluids used will provide an adequate "holdover time".
- 3) Organize an anti-icing process so that the final treatments are carried out as close to departure time possible.
- 4) Organize that the aircraft is positioned as close to the exit point with passengers on board, prior to final icing operation to reduce the time between deicing / anti-icing and takeoff.
- 5) Arrange the areas that can be seen from the cockpit to thaw first, so that during inspection before takeoff the crew to be sure that other areas of the aircraft are clean, because what thaws first it usually also that which freezes first.
- 6) Check that the engine is free to move by turning manually. If it is found that there is friction, let hot air pass through the core engine until freedom of movement is obtained. **DO NOT ATTEMPT TO START MOTOR- THIS COULD RESULT IN CATASTROPHIC DAMAGE.**

The areas where the de-icing and anti-freezing of aircraft must be carried out, are in Annex II, MOA.

**Pre-flight inspection**

The pre-flight inspection should be carried out after ground thawing, as close to departure time as possible. You should check carefully that there is no residual ice or snow on the aircraft, with particular emphasis on the following areas:

- Edges of wings, exit and surface of the wings.
- stabilizers
- Control surfaces
- Spoilers and airbrake
- Windows
- Landing gear and doors
- Brakes
- Air inlets and drains
- Engines checking that they rotate freely and APU
- Pitots, antennas and static.
- Fuel Tank Ventilation
- Pressure control valves
- Input and output of cooling air to the air conditioning packs.

G) Communications with the ground staff that carries out the treatment.**i. Before treatment.**

The crew must confirm with the ground staff how to make the deicing, the types of fluids used to get the expected Holdover times and their application in all the areas indicated on section seven of the AFM of each aircraft (Anexo II MOA).

ii. After treatment.

Once the treatment is finished, the crew must get from Ground staff the confirmation that the aircraft is free from contamination.

iii. Finished process notice.

The crew get the notice from ground staff that all the ground staff involved in the deicing leave the area.

	OPERATIONAL MANUAL Part A – General / Basic	Section 8.2.4
	8. Operational Procedures	Review 34
	8.2 Ground operational instructions	Page 10

Technical Log

The pilot must confirm that each time the thaw has been carried out they have filled in the deicing / anti-ice form and there is an appropriate and signed entry in the technical log, and that in particular they have indicated the start time, fluid type and concentration operation used for antifreeze protection. If there is a subsequent delay in departure or worsening weather conditions, you should use this information along with the above tables, to get a realistic idea of whether you need to repeat the entire process.

The anti-ice service provider must ensure that snowmelt information fluid type and concentration of the mixture used at the starting time of the operation is not provided to the crew until assured by suitably trained personnel that operation has been properly performed by a subsequent inspection application.

It is not permitted to apply a second layer of anti-icing fluid on the previous application. When time protection is running, it is always mandatory to complete the thaw operation before an application of frost protection in the case of an operation in two steps, or to repeat the whole thaw-frost process in the case of one step operation.



**MANUAL DE OPERACIONES
Parte A – General / Básico**

ANEXO II

TABLAS DE HOLDOVER Y ZONAS DE
DESHIELO/ANTI-HIELO

Anexo II

06/08/2019

Pág. 1

Winter 2020-2021

FAA Holdover Time Guidelines

**TABLE 2: HOLDOVER TIMES FOR SAE TYPE I FLUID ON CRITICAL AIRCRAFT SURFACES
COMPOSED PREDOMINANTLY OF ALUMINUM**

Outside Air Temperature ^{1,2}	Freezing Fog or Ice Crystals	Very Light Snow, Snow Grains or Snow Pellets ^{3,4}	Light Snow, Snow Grains or Snow Pellets ^{3,4}	Moderate Snow, Snow Grains or Snow Pellets ³	Freezing Drizzle ⁵	Light Freezing Rain	Rain on Cold Soaked Wing ⁶	Other ⁷
-3 °C and above (27 °F and above)	0:11 - 0:17	0:18 - 0:22	0:11 - 0:18	0:06 - 0:11	0:09 - 0:13	0:02 - 0:05	0:02 - 0:05	CAUTION: No holdover time guidelines exist
below -3 to -6 °C (below 27 to 21 °F)	0:08 - 0:13	0:14 - 0:17	0:08 - 0:14	0:05 - 0:08	0:05 - 0:09	0:02 - 0:05		
below -6 to -10 °C (below 21 to 14 °F)	0:06 - 0:10	0:11 - 0:13	0:06 - 0:11	0:04 - 0:06	0:04 - 0:07	0:02 - 0:05		
below -10 °C (below 14 °F)	0:05 - 0:09	0:07 - 0:08	0:04 - 0:07	0:02 - 0:04				

NOTES

- Type I fluid / water mixture must be selected so that the freezing point of the mixture is at least 10 °C (18 °F) below outside air temperature.
- Ensure that the lowest operational use temperature (LOUT) is respected.
- To determine snowfall intensity, the Snowfall Intensities as a Function of Prevailing Visibility table (Table 42) is required.
- Use light freezing rain holdover times in conditions of very light or light snow mixed with light rain.
- Includes light, moderate and heavy freezing drizzle. Use light freezing rain holdover times if positive identification of freezing drizzle is not possible.
- No holdover time guidelines exist for this condition for 0 °C (32 °F) and below.
- Heavy snow, ice pellets, moderate and heavy freezing rain, small hail and hail.

CAUTIONS

- The responsibility for the application of these data remains with the user.
- The time of protection will be shortened in heavy weather conditions. Heavy precipitation rates or high moisture content, high wind velocity, or jet blast may reduce holdover time below the lowest time stated in the range. Holdover time may be reduced when aircraft skin temperature is lower than outside air temperature.
- Fluids used during ground de/anti-icing do not provide in-flight icing protection.
- This table is for departure planning only and should be used in conjunction with pretakeoff check procedures.

A) TABLAS HOLDOVER



MANUAL DE OPERACIONES
Parte A – General / Básico

ANEXO II

TABLAS DE HOLDOVER Y ZONAS DE
DESHIELO/ANTI-HIELO

Anexo II

06/08/2019

Pág. 2

TABLE 4: GENERIC HOLDOVER TIMES FOR SAE TYPE II FLUIDS

Outside Air Temperature ¹	Fluid Concentration Fluid/Water By % Volume	Freezing Fog or Ice Crystals	Snow, Snow Grains or Snow Pellets ^{2,3}	Freezing Drizzle ⁴	Light Freezing Rain	Rain on Cold Soaked Wing ⁵	Other ⁶
-3 °C and above (27 °F and above)	100/0	0:55 - 1:50	0:25 - 0:50	0:30 - 1:00	0:20 - 0:35	0:08 - 0:45	CAUTION: No holdover time guidelines exist
	75/25	0:25 - 0:55	0:15 - 0:25	0:15 - 0:40	0:10 - 0:20	0:04 - 0:25	
	50/50	0:15 - 0:25	0:05 - 0:10	0:08 - 0:15	0:06 - 0:09		
below -3 to -8 °C (below 27 to 18 °F)	100/0	0:30 - 0:45	0:20 - 0:35	0:20 - 0:45	0:15 - 0:20		
	75/25	0:25 - 0:50	0:10 - 0:20	0:15 - 0:25	0:08 - 0:15		
below -8 to -14 °C (below 18 to 7 °F)	100/0	0:30 - 0:45	0:15 - 0:30	0:20 - 0:45 ⁷	0:15 - 0:20 ⁷		
	75/25	0:25 - 0:50	0:08 - 0:20	0:15 - 0:25 ⁷	0:08 - 0:15 ⁷		
below -14 to -18 °C (below 7 to 0 °F)	100/0	0:15 - 0:25	0:02 - 0:07				
	100/0	0:15 - 0:25 ⁸	0:01 - 0:03 ⁸				
below -25 °C to LOUIT (below -13 °F to LOUIT)	100/0	0:15 - 0:25 ⁸	0:00 - 0:01 ⁸				

NOTES

- 1 Ensure that the lowest operational use temperature (LOUT) is respected. Consider use of Type I fluid when Type II fluid cannot be used.
- 2 To determine snowfall intensity, the Snowfall Intensities as a Function of Prevailing Visibility table (Table 42) is required.
- 3 Use light freezing rain holdover times in conditions of very light or light snow mixed with light rain.
- 4 Includes light, moderate and heavy freezing drizzle. Use light freezing rain holdover times if positive identification of freezing drizzle is not possible.
- 5 No holdover time guidelines exist for this condition for 0 °C (32 °F) and below.
- 6 Heavy snow, ice pellets, moderate and heavy freezing rain, small hail and hail.
- 7 No holdover time guidelines exist for this condition below -10 °C (14 °F).
- 8 If the LOUIT is unknown, no holdover time guidelines exist below -24 °C (-11 °F).

CAUTIONS

- The responsibility for the application of these data remains with the user.
- The time of protection will be shortened in heavy weather conditions. Heavy precipitation rates or high moisture content, high wind velocity, or jet blast may reduce holdover time below the lowest time stated in the range. Holdover time may be reduced when aircraft skin temperature is lower than outside air temperature.
- Fluids used during ground de/anti-icing do not provide in-flight icing protection.
- This table is for departure planning only and should be used in conjunction with pretakeoff check procedures.



MANUAL DE OPERACIONES
Parte A – General / Básico

ANEXO II

TABLAS DE HOLDOVER Y ZONAS DE
DESHIELO/ANTI-HIELO

Anexo II

06/08/2019

Pág. 3

TABLE 4: GENERIC HOLDOVER TIMES FOR SAE TYPE II FLUIDS

Outside Air Temperature ¹	Fluid Concentration Fluid/Water By % Volume	Freezing Fog or Ice Crystals	Snow, Snow Grains or Snow Pellets ^{2,3}	Freezing Drizzle ⁴	Light Freezing Rain	Rain on Cold Soaked Wing ⁵	Other ⁶
-3 °C and above (27 °F and above)	100/0	0:55 - 1:50	0:25 - 0:50	0:30 - 1:00	0:20 - 0:35	0:08 - 0:45	CAUTION: No holdover time guidelines exist
	75/25	0:25 - 0:55	0:15 - 0:25	0:15 - 0:40	0:10 - 0:20	0:04 - 0:25	
	50/50	0:15 - 0:25	0:05 - 0:10	0:08 - 0:15	0:06 - 0:09		
below -3 to -8 °C (below 27 to 18 °F)	100/0	0:30 - 0:45	0:20 - 0:35	0:20 - 0:45	0:15 - 0:20		
	75/25	0:25 - 0:50	0:10 - 0:20	0:15 - 0:25	0:08 - 0:15		
below -8 to -14 °C (below 18 to 7 °F)	100/0	0:30 - 0:45	0:15 - 0:30	0:20 - 0:45 ⁷	0:15 - 0:20 ⁷		
	75/25	0:25 - 0:50	0:08 - 0:20	0:15 - 0:25 ⁷	0:08 - 0:15 ⁷		
below -14 to -18 °C (below 7 to 0 °F)	100/0	0:15 - 0:25	0:02 - 0:07				
	100/0	0:15 - 0:25 ⁸	0:01 - 0:03 ⁸				
below -25 °C to LOUIT (below -13 °F to LOUIT)	100/0	0:15 - 0:25 ⁸	0:00 - 0:01 ⁸				

NOTES

- 1 Ensure that the lowest operational use temperature (LOUT) is respected. Consider use of Type I fluid when Type II fluid cannot be used.
- 2 To determine snowfall intensity, the Snowfall Intensities as a Function of Prevailing Visibility table (Table 42) is required.
- 3 Use light freezing rain holdover times in conditions of very light or light snow mixed with light rain.
- 4 Includes light, moderate and heavy freezing drizzle. Use light freezing rain holdover times if positive identification of freezing drizzle is not possible.
- 5 No holdover time guidelines exist for this condition for 0 °C (32 °F) and below.
- 6 Heavy snow, ice pellets, moderate and heavy freezing rain, small hail and hail.
- 7 No holdover time guidelines exist for this condition below -10 °C (14 °F).
- 8 If the LOUIT is unknown, no holdover time guidelines exist below -24 °C (-11 °F).

CAUTIONS

- The responsibility for the application of these data remains with the user.
- The time of protection will be shortened in heavy weather conditions. Heavy precipitation rates or high moisture content, high wind velocity, or jet blast may reduce holdover time below the lowest time stated in the range. Holdover time may be reduced when aircraft skin temperature is lower than outside air temperature.
- Fluids used during ground de/anti-icing do not provide in-flight icing protection.
- This table is for departure planning only and should be used in conjunction with pretakeoff check procedures.

	MANUAL DE OPERACIONES Parte A – General / Básico	Anexo II
	ANEXO II	06/08/2019
	TABLAS DE HOLDOVER Y ZONAS DE DESHIELO/ANTI-HIELO	Pág. 4

INTENCIONADAMENTE EN BLANCO



**MANUAL DE OPERACIONES
Parte A – General / Básico**

ANEXO II

**TABLAS DE HOLDOVER Y ZONAS DE
DESHIELO/ANTI-HIELO**

Anexo II

Revisión 30

Pág. 5

B) ZONAS DE DESHIELO/ ANTI-HIELO

CESSNA 510

**TEMPORARY FAA APPROVED AIRPLANE FLIGHT MANUAL CHANGE
AIRPLANE DEICING**

MINIMUM DIRECT SPRAY AREAS	
• BRAKES	• STALL WARNING VANE
• ENGINE INLETS	• STATIC PORTS
• ENGINE EXHAUST	• WINDSHIELD
• PITOT HEADS	• WINDOWS (CABIN)
• RAM AIR INLETS	

A72165

Pay special attention to the gaps between the flight controls. All snow, ice, and slush must be removed from these gaps.

Engine inlets cleared of all snow, ice, and slush by hand only.

Remove snow, ice and slush from Stall Warning Vane by hand only.

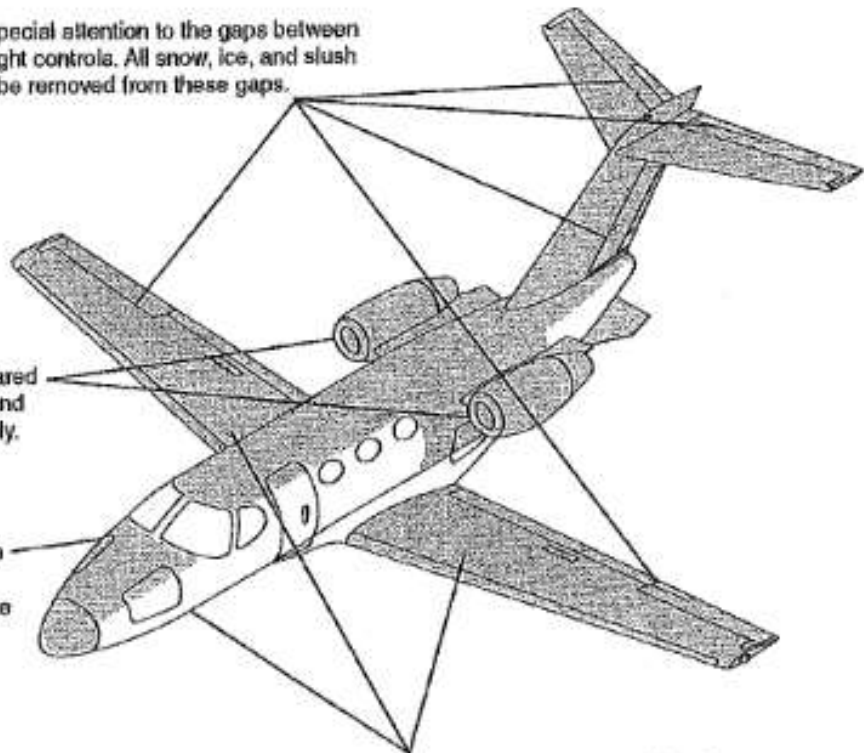

Landing gear doors and wheel wells must be free of snow, ice and slush.

NOTE

Shaded areas indicate essential areas to be deiced.



**MANUAL DE OPERACIONES
Parte A – General / Básico**

ANEXO II

**TABLAS DE HOLDOVER Y ZONAS DE
DESHIELO/ANTI-HIELO**

Anexo II

Revisión 30

Pág. 6

**TEMPORARY FAA APPROVED AIRPLANE FLIGHT MANUAL CHANGE
AIRPLANE ANTI-ICING**

MINIMUM DIRECT SPRAY AREAS

- BRAKES
- ENGINE INLETS
- ENGINE EXHAUST
- PITOT HEADS
- RAM AIR INLETS
- STALL WARNING VANE
- STATIC PORTS
- WINDSHIELD
- WINDOWS (CABIN)

472168

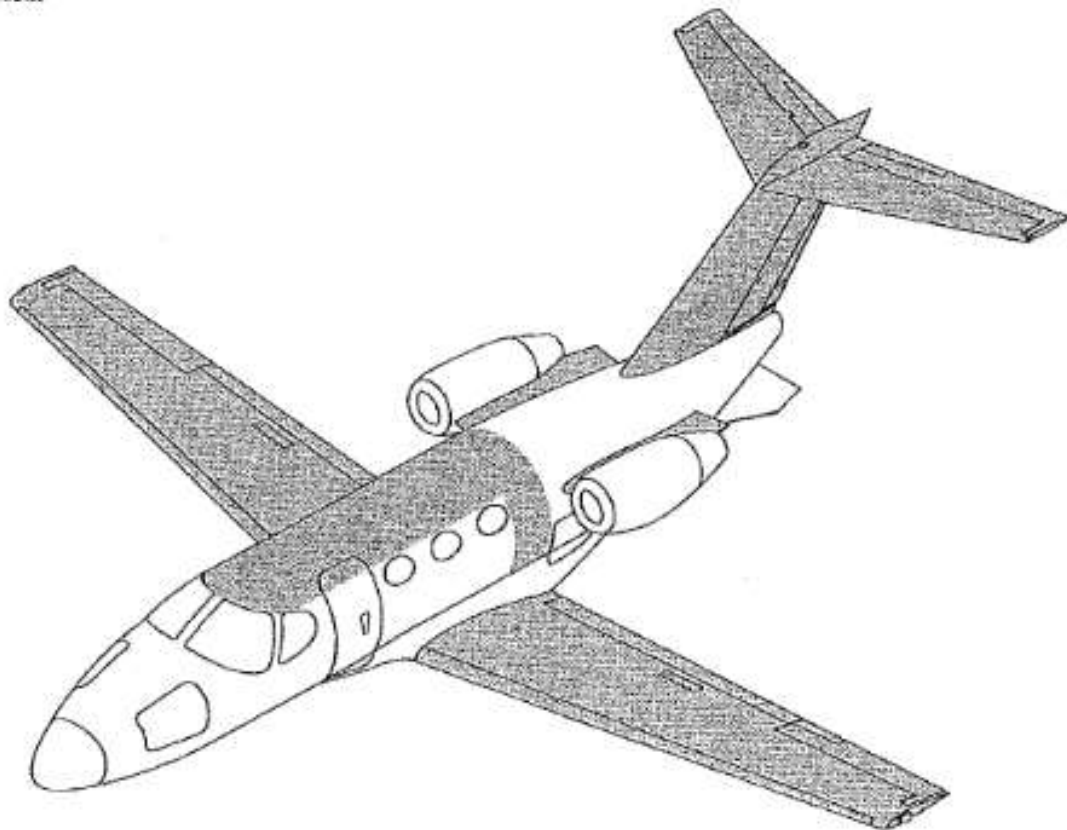

NOTE

The shaded areas indicate areas where anti-ice fluid is applied. Upper fuselage is anti-iced to preclude ice formation that could be ingested into engine inlets.



MANUAL DE OPERACIONES

Parte A – General / Básico

ANEXO II

TABLAS DE HOLDOVER Y ZONAS DE DESHIELO/ANTI-HIELO

Anexo II

Revisión 30

Pág. 7

CESSNA S-550

AIRPLANE DEICING

SHADED AREAS INDICATE ESSENTIAL AREAS TO BE DEICED

NOTE

AVOID DIRECT SPRAYING OF DEICING FLUID ON/IN THE FOLLOWING AREAS:

ENGINE INLETS
ENGINE EXHAUST
RAM AIR INLETS

BRAKES
WINDSHIELD
CABIN WINDOWS

PITOT HEADS
STATIC PORTS
AOA VANES

PAY SPECIAL ATTENTION TO THE GAPS BETWEEN THE FLIGHT CONTROLS. ALL SNOW, ICE AND SLUSH MUST BE REMOVED FROM THESE GAPS.

ENGINE INLETS CLEARED OF ALL SNOW, ICE AND SLUSH BY HAND ONLY.

REMOVE SNOW, ICE AND SLUSH FROM ANGLE OF ATTACK VANES BY HAND ONLY.

LANDING GEAR DOORS AND WHEEL WELLS MUST BE FREE OF SNOW, ICE AND SLUSH.

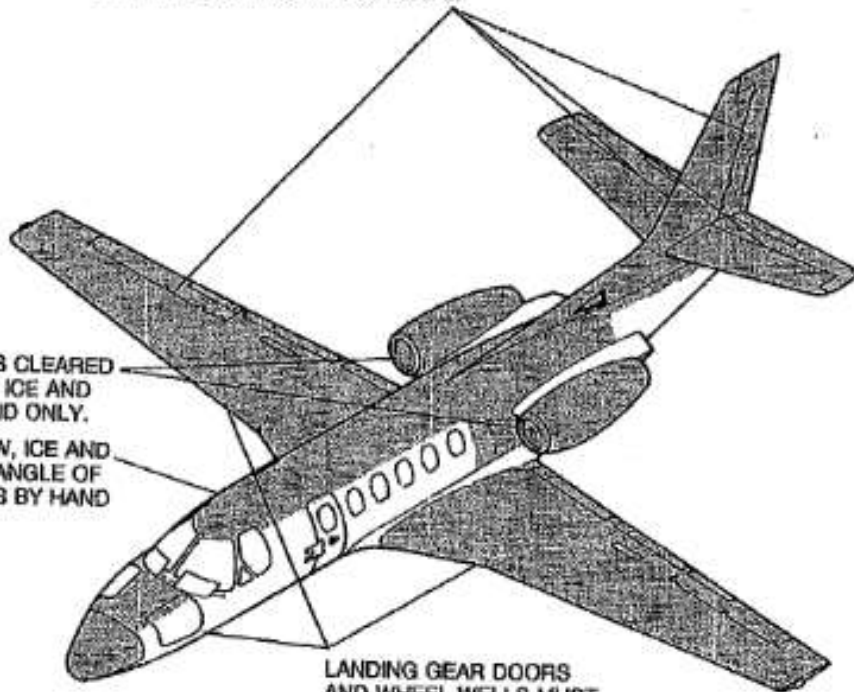

65102014



**MANUAL DE OPERACIONES
Parte A – General / Básico**

ANEXO II

**TABLAS DE HOLDOVER Y ZONAS DE
DESHIELO/ANTI-HIELO**

Anexo II

Revisión 30

Pág. 8

AIRPLANE ANTI-ICING

SHADED AREAS INDICATE ESSENTIAL AREAS TO BE ANTI-ICED

NOTE

**AVOID DIRECT SPRAYING OF ANTI-ICING FLUID ON/IN THE FOLLOWING
AREAS:**

**ENGINE INLETS
ENGINE EXHAUST
RAM AIR INLETS**

**BRAKES
WINDSHIELD
CABIN WINDOWS**

**PITOT HEADS
STATIC PORTS
AOA VANES**

